





-  Elettroaspiratore in lamiera d'acciaio completo di flangie di entrata e uscita.
-  Metal sheet steel fan complete with inlet and outlet flanges
-  Ventilateur en tôle d'acier avec brides d'entré et de sortie.
-  Ventilator aus Stahlblech mit Drück und Sauganschlüssen.
-  Aspirador en lámina de acero con bocas de entrada y salida.

230V-400V / 3phase / 50Hz

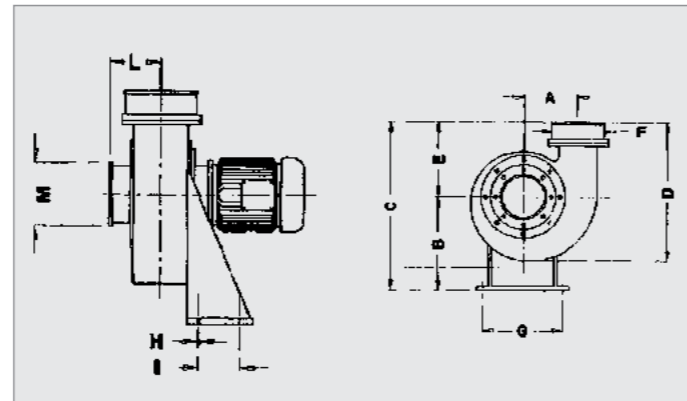
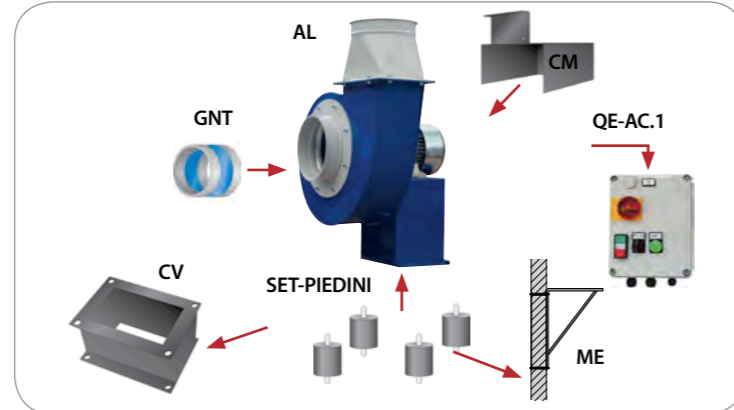

	AL 50	AL 100	AL 150	AL 200	AL 300	AL 400	AL 550	AL 750	AL 1000	AL 1500	AL 2000
	P_t [mmH₂O]										
Q [m ³ /h]											
100		85	120								
200		87	123		140						
300		88	124	124	140						
350	56	89	126	125	140						
400	58,5	90	128	126	140						
500	61	92	132	127	140						
600	67,5	93	137	128	140						
700	67,5	98	142	135	141						
800	63	102	145	136	142						
880	60	105	147	137	142						
900		107	150	137	142						
1000		110	153	138	144						
1100		112	157	140	147						
1200		113	162	143	150						
1300		113	167	147	152						
1500		112	172	158	162	270					
1700		107	172	167	170	275	275				
1800		106	170	173	177	287	272				
1900		105	167	178	182	286	270				
2100		100		188	190	285	268				
2160				187	193	284	264				
2400					194	281	260				
2520					188	279	259				
2700					185	275	258				
2880					184	271	257				
2950					183	267	256				
3000						264	255	325	340		
3240						260	252	322	338		
3400						254	250	320	336		
3600						247	245	317	334	360	
3800						238	240	315	332	370	
4000						232	230	310	330	387	
4100						220	220	305	327	381	385
4320						214	205	295	324	377	387
4680						195	195	285	322	374	388
4750						180	180	280	318	369	390
5000						170	168	275	312	361	393
5400						153	155	270	295	350	388
6000						81	145	250	275	346	382
6150							110	240	268	340	378
6500							90	225	255	333	368
6850								215	240	325	360
7000								200	230	320	355
7650								160	195	305	350
8000								132	175	285	341
8500								105	150	260	305
9000									118	240	300
9100									108	230	292
9500										210	285
10000										200	275
10800										160	220
11000										150	225
11500										118	200
12000											180
13000											125

Mod	A	B	C	D	E	F,M (.../C)	F,M (.../D)	G	H	I	L	Kg.	Lbs.	HP	Kw	r.p.m.	dB
AL-50	92	190	468	492	278	150	160	195	8,5	65	120	12	26	0,5	0,37	2800	66
AL-100	151	283	601	486	318	180	160	265	8,5	95	125	20	44	1	0,75	2800	68
AL-150	151	283	601	486	318	180	160	265	8,5	95	125	22	48	1,5	1,1	2800	72
AL-200	196	374	756	624	382	200	200	250	8,5	130	135	32	70	2	1,5	2800	75
AL-300	196	374	756	624	382	200	200	250	8,5	130	135	35	77	3	2,2	2800	78
AL-400	286	500	965	835	465	250	250	289	12	197	187	77	170	4	3	2800	80
AL-550	286	500	965	835	465	250	250	289	12	197	187	82	180	5,5	4	2800	81
AL-750	321	560	1080	935	520	300	315	337	12	237	201	118	260	7,5	5,5	2800	84
AL-1000	321	560	1080	935	520	350	355	337	12	237	201	128	281	10	7,5	2800	85
AL-1500	355	600	1180	1052	580	380	400	395	14	337	217	203	446	15	11	2800	89
AL-2000	355	600	1180	1052	580	400	400	395	14	337	217	215	473	20	15	2800	89